

MIT MUFFENANSCHLUSS, EMPFOHLEN FÜR DEN EINSATZ AN MASCHINEN MIT MITTLERER LEISTUNG.

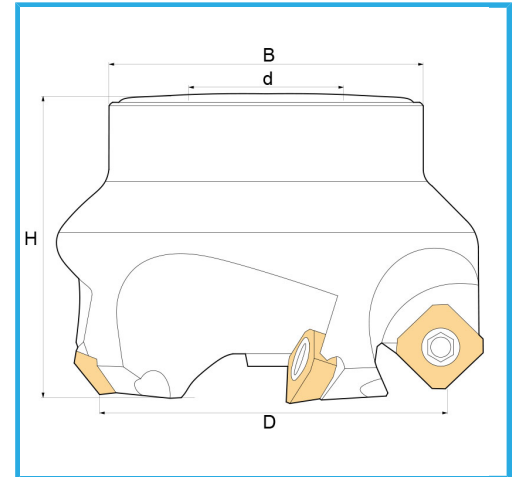

D	40 mm
H	45 mm
B	53 mm
d	16 mm
Z	3
Schrauben	KV500
Einsatz (nicht im Lieferumfang enthalten)	SEHX1204... / SEHT1204...
Bruttogewicht	0,50 kg
Verpackungsmaße	80x80x90 h mm
EAN-Code	8012667180966

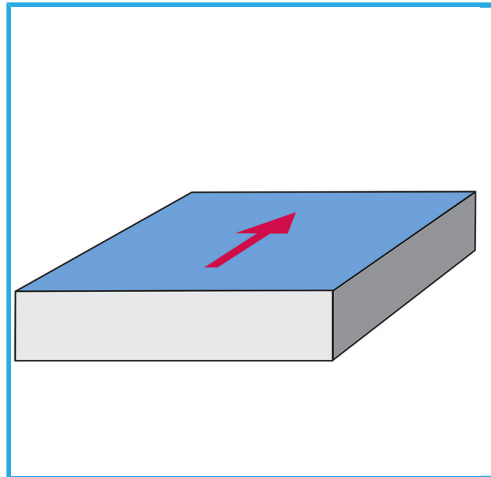

Box



Satiniert



Vernickelt



Extern