

ER32 DIN 6499/B UTILIZZABILE CON MANDRINI PORTAPINZE.

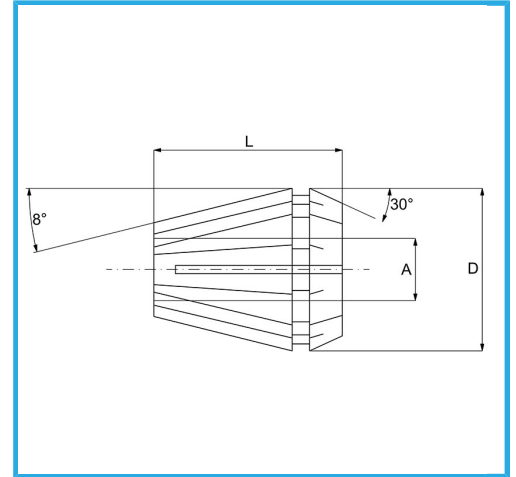

€15,70



Capacità A	19-20 mm
D	33 mm
L	40 mm
Peso lordo	0,09 kg
Dimensioni imballo	39x39x47 h mm
Codice EAN	8012667142070



Scatola



Rettificato

65Mn