

DIN 2080, CORPO MANDRINO BILANCIATO, PER FRESE CILINDRICHE FRONTALI SECONDO NORMA DIN 481, PER FRESE CON SCANALATURA...

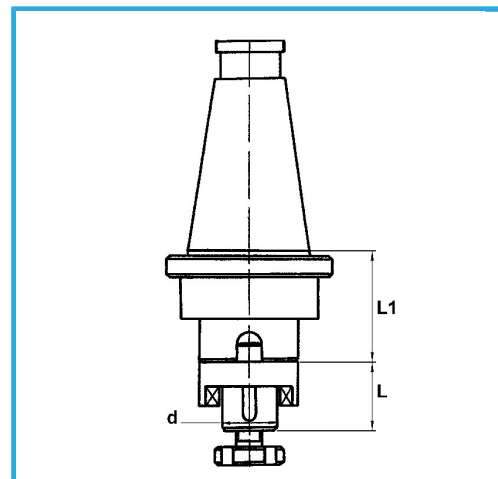

€158,00



ISO	50
d - h6	27 mm
L	33 mm
L1	35 mm
Peso lordo	3,57 kg
Codice EAN	8012667008345



Scatola



Rettificato

18Ni
CrMo5