

DIN 2080, CORPO MANDRINO BILANCIATO. EQUILIBRATURA 2.000 RPM.

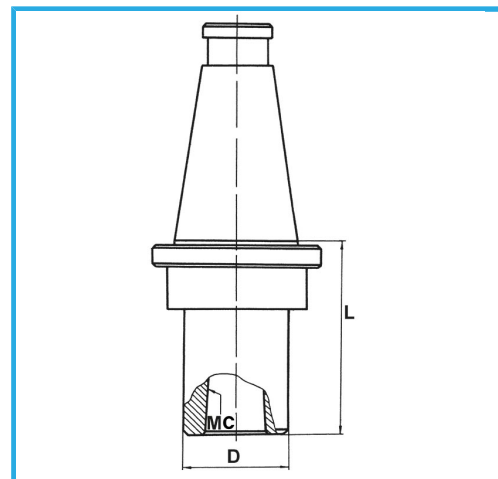

€187,00



ISO	50
CM	4
D	50 mm
L	65 mm
Peso lordo	3,14 kg
Codice EAN	8012667008260



Scatola



Rettificato

18Ni
CrMo5