

DIN 2080, CORPO MANDRINO BILANCIATO. EQUILIBRATURA 2.000 RPM.

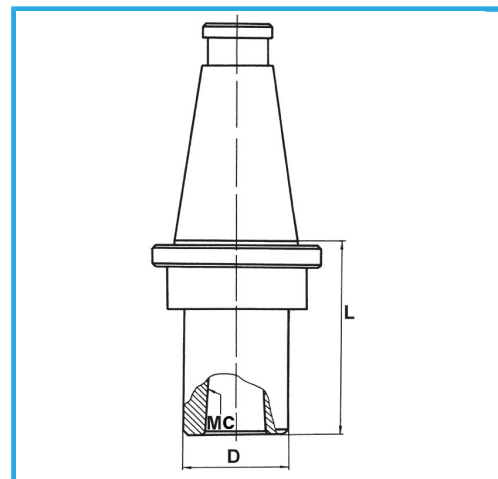

€142,00



ISO	40
CM	4
D	50 mm
L	94 mm
Peso lordo	1,49 kg
Codice EAN	8012667008239



Scatola



Rettificato

18Ni
CrMo5