

DIN 2080, CORPO MANDRINO BILANCIATO. EQUILIBRATURA 2.000 RPM.

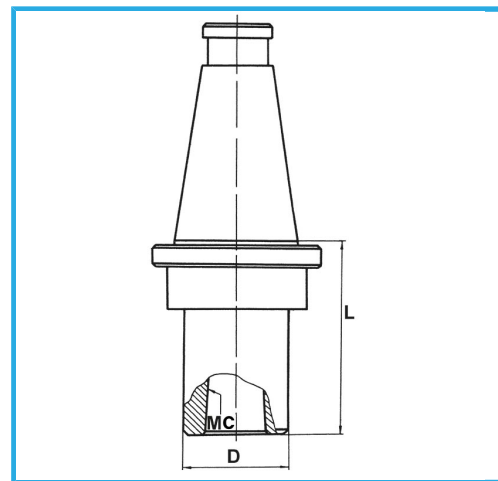

€127,00



ISO	40
CM	3
D	40 mm
L	64 mm
Peso lordo	1,12 kg
Codice EAN	8012667008222



Scatola



Rettificato

18Ni  
CrMo5