

DIN 69871/A, CORPO MANDRINO BILANCIATO. EQUILIBRATURA 12.000 RPM.

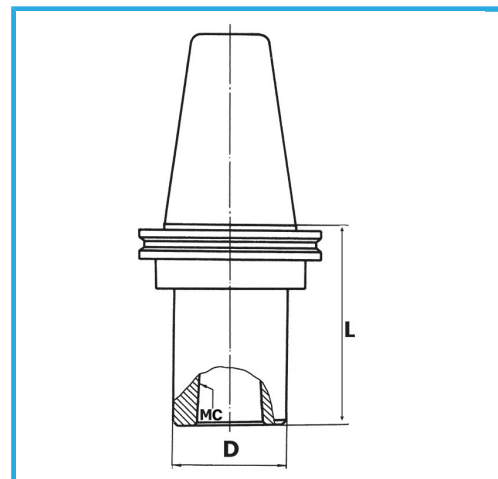

€133,00



ISO	40
CM	4
D	50 mm
L	98 mm
Peso lordo	1,00 kg
Codice EAN	8012667007935



Scatola



Rettificato

18Ni  
CrMo5