

DIN 69871/A, CORPO MANDRINO BILANCIATO, CON ASOLA DI ESTRAZIONE PER UTENSILI. EQUILIBRATURA 12.000 RPM.

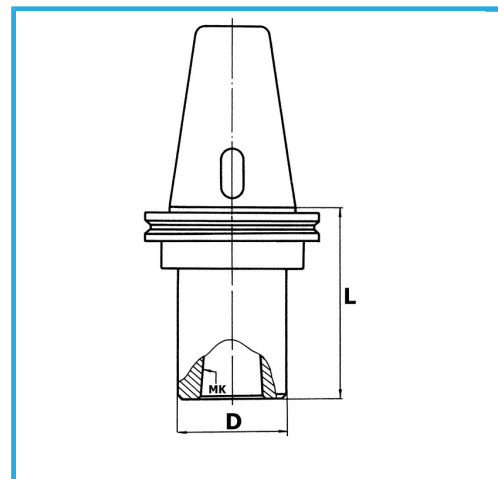

€105,00



ISO	40
CM	4
D	50 mm
L	98 mm
Peso lordo	1,33 kg
Codice EAN	8012667007805



Scatola



Rettificato

18Ni  
CrMo5