

DIN 69871/A, CORPO MANDRINO BILANCIATO, CON ASOLA DI ESTRAZIONE PER UTENSILI. EQUILIBRATURA 12.000 RPM.

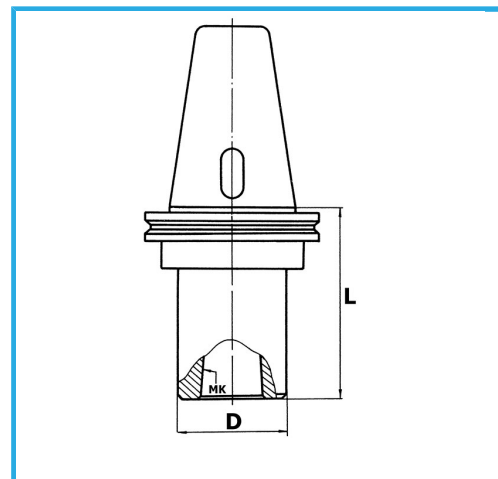

€211,00



ISO	50
CM	3
D	40 mm
L	50 mm
Peso lordo	2,85 kg
Codice EAN	8012667007874



Scatola



Rettificato

18Ni
CrMo5