

DIN 69871/A, CORPO MANDRINO BILANCIATO, CON ASOLA DI ESTRAZIONE PER UTENSILI. EQUILIBRATURA 12.000 RPM.

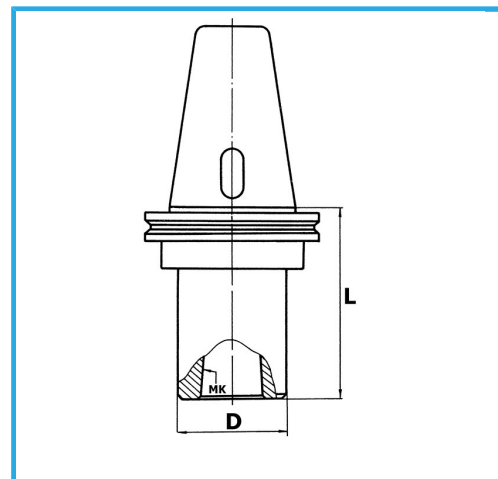

€105,00



ISO	40
CM	1
D	25 mm
L	45 mm
Peso lordo	0,97 kg
Codice EAN	8012667007775



Scatola



Rettificato

18Ni  
CrMo5