

DIN 69871/A, CORPO MANDRINO BILANCIATO, PER FRESE (WELDON)  
SECONDO NORMA DIN 1835 B E DIN 6535 HB. FORNITO CON VITE DI...

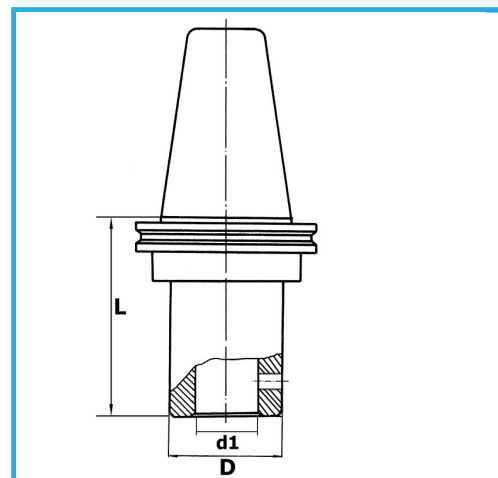

€133,00



ISO	50
d1 - h6	16 mm
D	48 mm
L	80 mm
Peso lordo	3,38 kg
Codice EAN	8012667193171



Scatola



Rettificato

18Ni  
CrMo5