

DIN 69871/A, CORPO MANDRINO BILANCIATO, PER FRESE (WELDON)  
SECONDO NORMA DIN 1835 B E DIN 6535 HB. FORNITO CON VITE DI...

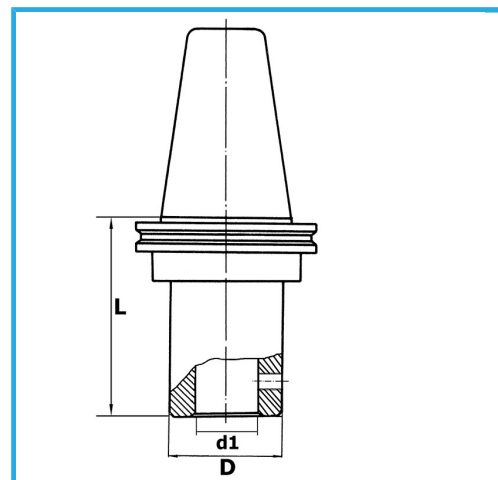

€96,50



ISO	40
d1 - h6	16 mm
D	48 mm
L	70 mm
Peso lordo	1,34 kg
Codice EAN	8012667195533



Scatola



Rettificato

18Ni  
CrMo5