

DIN 69871/A, CORPO MANDRINO BILANCIATO, PER FRESE
CILINDRICHE FRONTALI SECONDO NORMA DIN 481, PER FRESE CON
SCANALATURA...

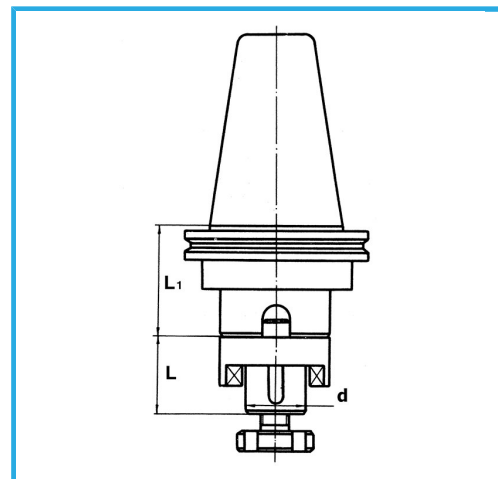

€132,00



ISO	40
d-h6	32 mm
L	38 mm
L1	45 mm
Equilibratura rpm	12000
Peso lordo	1,70 kg
Codice EAN	8012667008062



Scatola

18Ni
CrMo5



Rettificato