

DIN 2080, AUSGEWUCHTETES SPANNFUTTERGEHÄUSE, MIT  
ABSAUGSCHLITZ FÜR WERKZEUGE. AUSWUCHTDREHZAHN 12.000  
RPM.

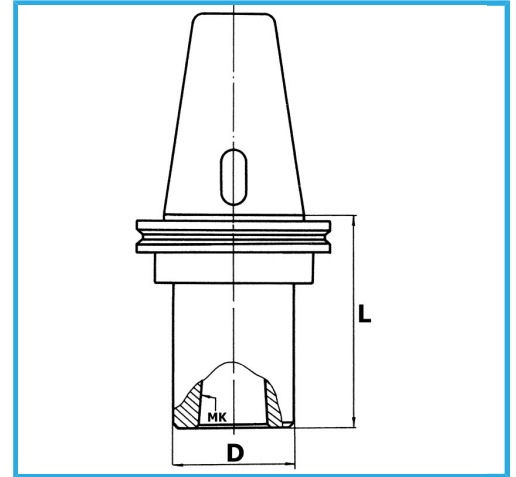

ISO	50
CM	2
D	32 mm
L	60 mm
Bruttogewicht	0,97 kg
EAN-Code	8012667407193



Box



Korrigiert