

PER IL MONTAGGIO DI UTENSILI CON GAMBO CONICO MORSE.

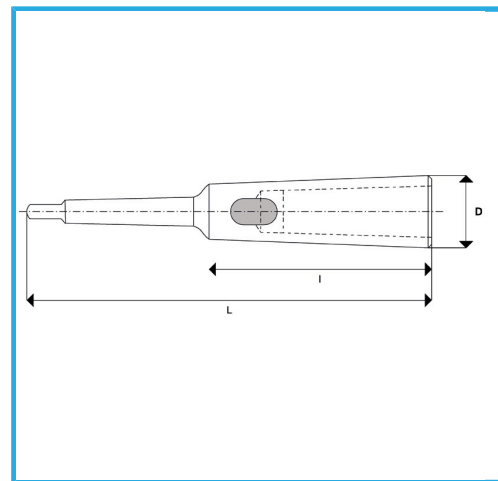

€40,80



CM Esterno	4
CM Interno	2
L	215 mm
I	97,5 mm
D	30 mm
Peso lordo	1,00 kg
Codice EAN	8012667349660



Scatola



Temprato



Acciaio



Rettificato