

PER IL MONTAGGIO DI UTENSILI CON GAMBO CONICO MORSE.

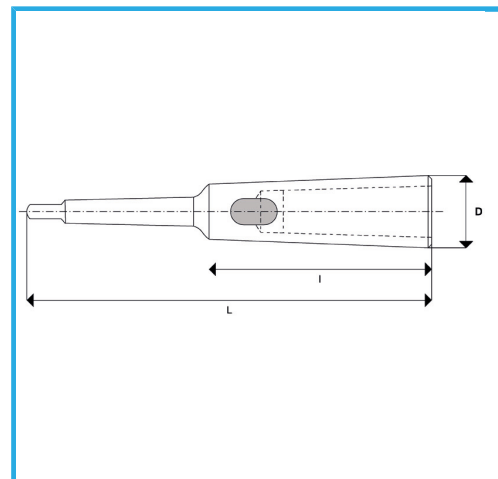

€38,10



CM Esterno	3
CM Interno	3
L	215 mm
I	121 mm
D	36 mm
Peso lordo	0,90 kg
Codice EAN	8012667349639



Scatola



Temprato



Acciaio



Rettificato