

PER IL MONTAGGIO DI UTENSILI CON GAMBO CONICO MORSE.

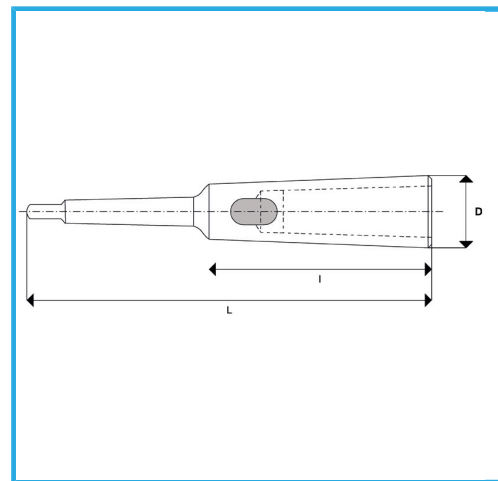

€78,70



CM Esterno	4
CM Interno	5
L	300 mm
I	182,5 mm
D	63 mm
Peso lordo	3,40 kg
Codice EAN	8012667349691



Scatola



Temprato



Acciaio



Rettificato