

PER IL MONTAGGIO DI UTENSILI CON GAMBO CONICO MORSE.

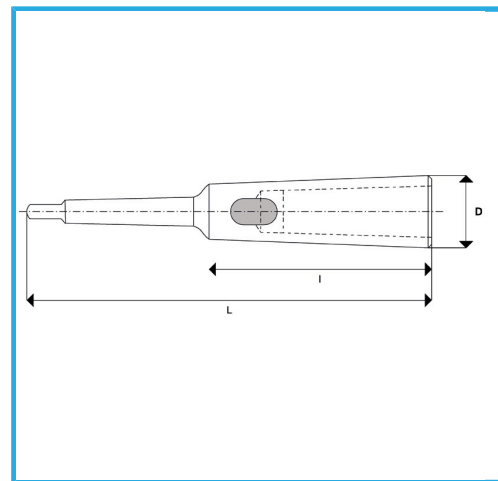

€64,10



CM Esterno	5
CM Interno	1
L	232 mm
I	82,5 mm
D	20 mm
Peso lordo	1,68 kg
Codice EAN	8012667349707



Scatola



Temprato



Acciaio



Rettificato