

PER IL MONTAGGIO DI UTENSILI CON GAMBO CONICO MORSE.

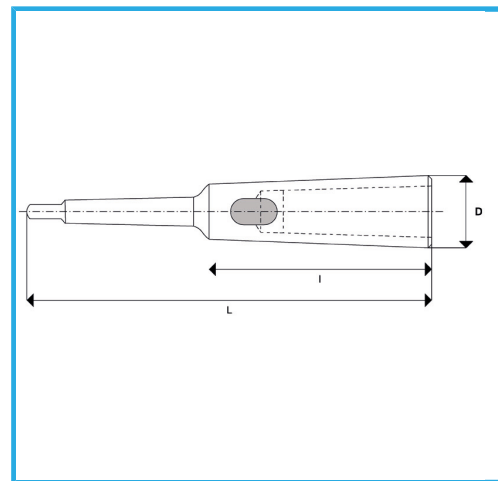

€65,20



CM Esterno	5
CM Interno	2
L	247 mm
I	97,5 mm
D	30 mm
Peso lordo	1,92 kg
Codice EAN	8012667349714



Scatola



Temprato



Acciaio



Rettificato