

PER IL MONTAGGIO DI UTENSILI CON GAMBO CONICO MORSE.

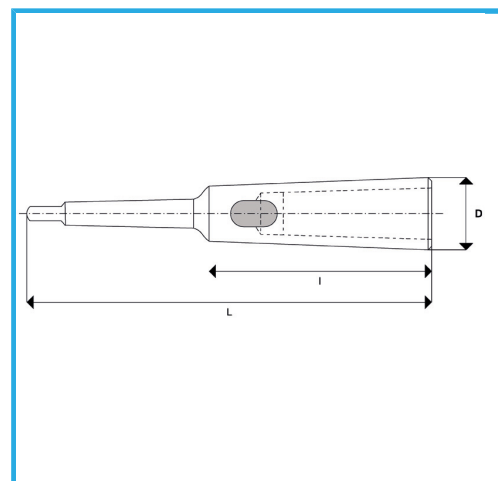

€65,20



CM Esterno	5
CM Interno	3
L	268 mm
I	118,5 mm
D	36 mm
Peso lordo	2,15 kg
Codice EAN	8012667349721



Scatola



Temprato



Acciaio



Rettificato