

PER IL MONTAGGIO DI UTENSILI CON GAMBO CONICO MORSE.

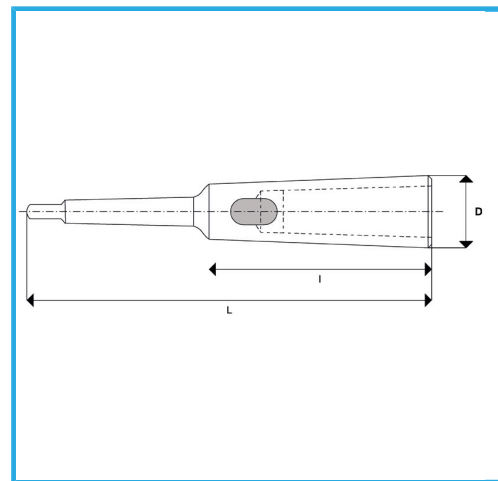

€54,90



CM Esterno	4
CM Interno	4
L	265 mm
I	147,5 mm
D	48 mm
Peso lordo	1,90 kg
Codice EAN	8012667349684



Scatola



Temprato



Acciaio



Rettificato